

## Intelligent Fastening for Membrane Roofing Systems

Fixing thermal insulation and waterproofing membranes to steel, plywood and concrete decks



# Intelligent fastening for membrane roofing systems

Developed by EJOT® for successful single ply membrane installations

EJOT's single tube-washer and fastener combination created what has now become an industry standard solution to secure insulation, with or without membrane, back to the deck. That means our customers enjoy a simpler route to purchase, easier stock management and a faster, high-quality installation.

Our range of flat roofing products has grown to provide the widest choice for fully mechanical or part-bonded systems – ticking all the boxes set out by guidelines published by the Single Ply Roofing Association (SPRA).

Quality products are only as good as the technical support behind the range. EJOT's Applitec team are based at our UK manufacturing centre in Yorkshire, providing data and guidance to ensure correct specification from planning to purchase to installation.

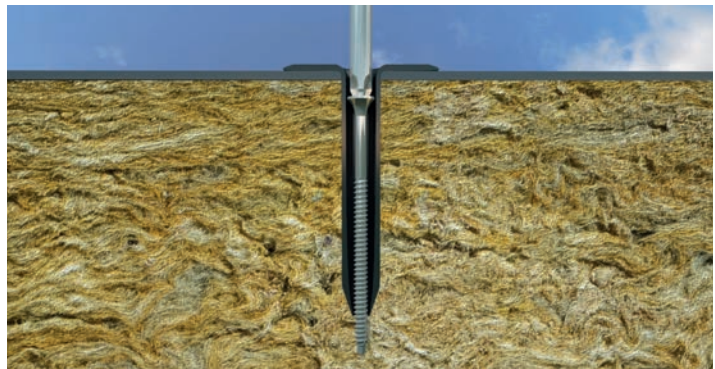

**Call 01977 68 70 40**

or email: [info@ejot.co.uk](mailto:info@ejot.co.uk)

This QR code takes you straight to our flat roofing product overview video.

Subscribe to our EJOT UK YouTube channel to see all of our videos.



ETA-07/0013  
See details on page 5

## Contents



Cover image courtesy of IPS Group,  
North Yorkshire:  
Single ply membrane roof installation at  
the Waendel Leisure Centre, Wellingborough.

### Washer / fastener combinations table

Typical combinations in use on UK flat roofing installations.....4

### Tube-washer overview

Guide to EJOT tube-washer applications and size range .....6

### Fastener overview: steel and timber decks

Guide to EJOT fastener applications and size range .....8

### Time-saving products and supply options

Innovations for the EJOT flat roofing range .....11

### Mechanical installation systems: steel and timber decks

Standard tube-washer / carbon steel fastener tables .....12

Standard tube-washer / stainless steel fastener tables .....13

Heavy duty tube-washer / carbon steel fastener tables.....14

Heavy duty tube-washer / stainless steel fastener tables.....15

### Fastener overview: concrete decks

Guide to EJOT fastener applications and size range .....16

### Mechanical installation systems: concrete decks

Tube-washer / fastener options and tables .....18

Tube-washer / fastener combinations for tapered roof systems .....20

### Ancillary flat roofing products

Tooling for installations into concrete decks .....22

Ancillary fastenings and washers .....23

FP profile bar for structural edge and parapet fastening .....28

### Part-mechanical installation systems: steel and timber decks

75mm tube-washer / steel fastener tables..... 29-31

### EJOT® Opticore:

Self-coring fixing for membrane faced composite panels .....32

### EJOT® EJObar











Membrane-friendly support bar for single ply PVC roofing.....34

### Technical support from EJOT® Applitec

Support services on and off site.....36

## Typical washer + fastener combinations

The tables below show suitable combinations of EJOT washers and fasteners that are regularly used in application on UK flat roofing projects. For more detailed information please see specific product application data within this brochure.

STRESS PLATES						
	HTK 2G 50	HTK 2G 75	EcoTek 50	EcoTek-T-50	HTK-S	Flat roof profile FP
						
TKR-4.8	✓ 	✓	✓ 	✓	✓	✓
TKE-4.8	✓ 	✓	✓ 	✓	✓	✓
TKR-4-4.8	✓	✓	✓	✓	✓	✓
TKR-ZT6-5.5			✓	✓		✓
VHT-E-4.8	✓	✓	✓	✓	✓	✓
FBS-R-6.3			✓ 	✓		✓
JBS-R-7.5			✓	✓		✓
JT2-ST-2-6.0			✓ 	✓		✓
JT3-ST-2-6.0			✓ 	✓		✓
FPS-E-8.0			✓	✓		✓



**ETA product combinations**

Products marked throughout with this symbol are fully detailed in ETA-07/0013.

This ETA document details approvals appropriate to specific washer and fastener combinations. Please contact the EJOT Technical Team to obtain the complete document.



**FM approved product combinations**

Products marked throughout with this symbol indicates an FM approved combination. Contact the EJOT Technical Team for further details, or visit FM Roofnav database at [www.roofnav.com](http://www.roofnav.com)

STRESS PLATES						
HTV 82/40-5 'Deep Dimple'	HTV 82/40-7 'Deep Dimple'	HTV 82/40 TK	HTV 82/40 F	HTV 40 RU	HTV 70 RU	
						TKR-4.8 
✓		✓	✓	✓	✓	TKE-4.8 
✓		✓	✓	✓	✓	TKR-4-4.8 
	✓		✓	✓	✓	TKR-ZT6-5.5 
✓		✓	✓	✓	✓	VHT-E-4.8 
	✓		✓	✓	✓	FBS-R-6.3 
						JBS-R-7.5 
	✓		✓		✓	JT2-ST-2-6.0 
	✓		✓		✓	JT3-ST-2-6.0 
			✓	✓		FPS-E-8.0 

# The best combinations that have your flat roofing installations covered.

EJOT tube-washers have been developed to provide high load bearing strengths at a variety of lengths. Manufactured from high grade materials, each tubular design has been created to deliver total efficiency when combined with the correct EJOT fastener for a designated substrate.

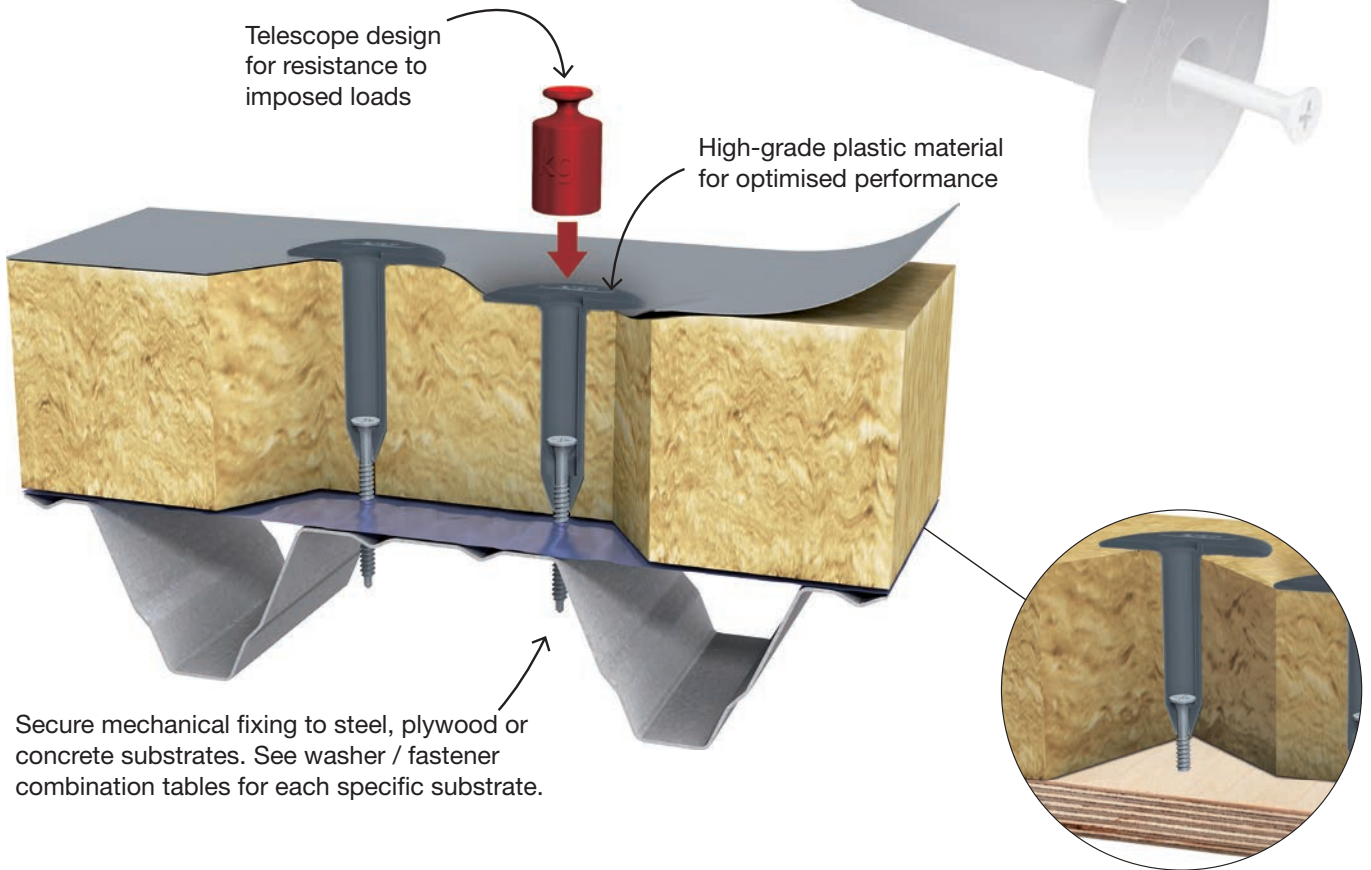
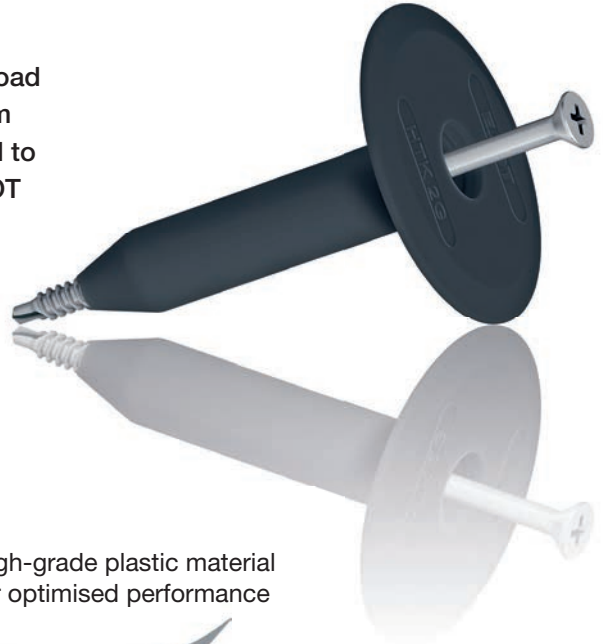

ETA-07/0013  
See details on page 5

**HTK 2G 50 tube-washer**

Combines with either TKR or TKE fastener types to fix insulation with or without the single layer waterproof membrane to 0.7mm to 1.2mm steel or plywood / timber and OSB decks. Available as separate components or pre-assembled on request.

Ø x L (mm)	Washer Ø (mm)	Effective Recess Tube Length (mm)	Overall Tube Length (mm)	Min Qty
50 x 15	50	15	25	100
50 x 35	50	35	45	100
50 x 55	50	55	65	100
50 x 95	50	95	105	100
50 x 145	50	145	155	100
50 x 185	50	185	195	100
50 x 225	50	225	235	100
50 x 275	50	275	285	100
50 x 325	50	325	335	100

Order Example: HTK 2G 50 x 15



**HTK 2G 75 tube-washer**

Developed to meet guidelines set out by the Single Ply Roofing Association, for bonded / mechanical hybrid installations. For securing insulation back into either plywood / timber and OSB decks or profiled steel decks.

Ø x L (mm)	Washer Ø (mm)	Effective Recess Tube Length (mm)	Overall Tube Length (mm)	Min Qty
75 x 35	75	35	45	100
75 x 55	75	55	65	100
75 x 95	75	95	105	100
75 x 145	75	145	155	100

Order Example: HTK 2G 75 x 35



**EcoTek 50**

The unique material composition of the EJOT EcoTek® 50mm tube-washer design ensures a fast, reliable and secure installation for thermal insulation, and membrane-through-insulation fixing to concrete substrates.

Combines with either FBS-R or FPS-E fastener types to fix insulation and single layer waterproof membrane to concrete and aerated concrete decks.

Ø x L (mm)	Washer Ø (mm)	Effective Recess Tube Length (mm)	Overall Tube Length (mm)	Min Qty
50 x 35	50	25	35	100
50 x 65	50	55	65	100
50 x 85	50	75	85	100
50 x 105	50	95	105	100
50 x 135	50	125	135	100
50 x 165	50	155	165	100
50 x 195	50	185	195	100
50 x 225	50	215	225	100
50 x 275	50	265	275	100
50 x 335	50	325	335	100

Order Example: EcoTek 50 x 35



**EcoTek T-50** NEW TO RANGE

Where increased resistance is required for unusually high load applications, the EcoTek® T-50 tube-washer offers a super-strength versatile solution that is compatible with the complete range of EJOT Dabo® / concrete and aerated concrete fasteners.

**NOTE:**

Four additional teeth under the head ensure a maximum fixing retention of the roofing membrane.

See image right.

Ø x L (mm)	Washer Ø (mm)	Effective Recess Tube Length (mm)	Overall Tube Length (mm)	Min Qty
50 x 65	50	55	65	100
50 x 85	50	75	85	100
50 x 105	50	95	105	100
50 x 135	50	125	135	100
50 x 165	50	155	165	100
50 x 195	50	185	195	100
50 x 225	50	215	225	100

Order Example: EcoTek T-50 x 105



## EJOT Dabo® carbon steel fasteners

EJOT Dabo® flat roofing fasteners are engineered with a countersunk head and combine with the HTK 2G 50 tube-washer for fixing single layer membrane, insulation, or both back to substrate.

EJOT Dabo® TKR fasteners are manufactured with a thread form and drill point to maximise mechanical performance and Climadur coated to meet the stringent requirements of EAD 030351-00-0402 after 15 Kesternich cycles.

### EJOT Dabo® carbon steel fastener TKR-4.8



**Organic corrosion resistant finish**

Case-hardened steel with Climadur organic coating for improved corrosion resistance (15 Kesternich cycles, DIN 50018).

**Application**

Insulation and single layer waterproof membrane.

0.7mm to 1.2mm steel or plywood deck.

N.B. Fastener is fully threaded up to and including the TKR 4.8 x 50 only.

See table on Pages 4 & 5 for washer compatibility guide.

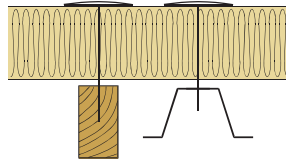

**Drive Tool**



ETA-07/0013  
See Page 5

Ø x L (mm)	Deck Type		Min Qty
	Steel Deck Min Insulation Max	Plywood Min Insulation Max	
4.8 x 35	5 - 15	N/A	100
4.8 x 50	5 - 30	5 - 10	100
4.8 x 60	15 - 40	10 - 20	100
4.8 x 70	25 - 50	20 - 30	100
4.8 x 80	35 - 60	30 - 40	100
4.8 x 90	45 - 70	40 - 50	100
4.8 x 100	55 - 80	50 - 60	100
4.8 x 110	65 - 90	60 - 70	100
4.8 x 120	75 - 100	70 - 80	100
4.8 x 130	85 - 110	80 - 90	100
4.8 x 140	95 - 120	90 - 100	100
4.8 x 150	105 - 130	100 - 110	100
4.8 x 160	115 - 140	110 - 120	100
4.8 x 170	125 - 150	120 - 130	100
4.8 x 180	135 - 160	130 - 140	100
4.8 x 200	155 - 180	150 - 160	100
4.8 x 220	175 - 200	170 - 180	100
4.8 x 240	195 - 220	190 - 200	100
4.8 x 260	215 - 240	210 - 220	100
4.8 x 280	235 - 260	230 - 240	100
4.8 x 300	255 - 280	250 - 260	100

**Order Example TKR-4.8 x 80**

### EJOT Dabo® carbon steel fastener TKR-4-4.8



**Organic corrosion resistant finish**

Case-hardened steel with Climadur organic coating for improved corrosion resistance (15 Kesternich cycles, DIN 50018).

**Application**

Deck overlap solution when fixing back insulation and membrane.

1.5mm – 4.0mm steel.

See table on Pages 4 & 5 for washer compatibility guide.

Call EJOT Technical for specific application guidance.



Ø x L (mm)	Order description	Min Qty
4.8 x 70	TKR-4-4.8 x 70	100
4.8 x 90	TKR-4-4.8 x 90	100
4.8 x 110	TKR-4-4.8 x 110	100

**Order Example TKR-4-4.8 x 70**

**Drive Tool**



ETA-07/0013  
See Page 5



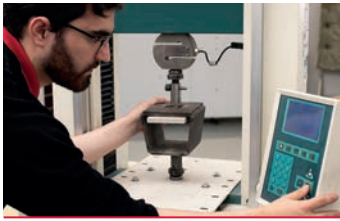

**EJOT Technical Services**

For technical guidance where material specification may relate to special environmental conditions, please call our technical team on **01977 687040**

Applications where substrates may have an unknown carrying capacity, we provide on-site pull-out testing, meeting the requirements of EAD 030351-00-0402.

**EJOT Dabo® carbon steel fastener**  
**TKR-ZT6-5.5** NEW TO RANGE



**Organic corrosion resistant finish**

Case-hardened steel with Climadur organic coating for improved corrosion resistance (15 Kesternich cycles, DIN 50018).

**Application**

Solution for applications when fixing insulation and membrane back to mild steel. For example, rooflight trim.

3.0mm – 6.0mm steel or plywood decks.

See table on Pages 4 & 5 for washer compatibility guide.

Call EJOT Technical for specific application guidance.



**Drive Tool**



Ø x L (mm)	Order description	Min Qty
5.5 x 35	TKR-ZT6-5.5 x 35	100
5.5 x 70	TKR-ZT6-5.5 x 70	100
5.5 x 90	TKR-ZT6-5.5 x 90	100
5.5 x 110	TKR-ZT6-5.5 x 110	100
<b>Order Example TKR-ZT6-5.5 x 110</b>		



ETA-07/0013  
See Page 5

**EJOT carbon steel fastener**  
**JT2-ST2-6.0** NEW TO RANGE



**Organic corrosion resistant finish**

Case-hardened steel EJOGuard coating for enhanced corrosion resistance, conforming to DIN 50018.

**Application**

Heavy Duty Solution for higher load requirements.

For fixing insulation and membrane to 0.7mm to 1.6mm steel or plywood decks.



**Tube-washer compatibility**

This fastener is used in conjunction with the EJOT EcoTek tube-washer for its higher strength capability.

See table on Pages 4 & 5 for washer compatibility guide.

Call EJOT Technical for specific application guidance.

**Drive Tool**



Ø x L (mm)	Order description	Min Qty
6.0 x 40	JT2-ST-2-6.0 x 40	100
6.0 x 60	JT2-ST-2-6.0 x 60	100
6.0 x 80	JT2-ST-2-6.0 x 80	100
6.0 x 100	JT2-ST-2-6.0 x 100	100
6.0 x 120	JT2-ST-2-6.0 x 120	100
6.0 x 140	JT2-ST-2-6.0 x 140	100
6.0 x 160	JT2-ST-2-6.0 x 160	100
6.0 x 180	JT2-ST-2-6.0 x 180	100
6.0 x 200	JT2-ST-2-6.0 x 200	100
<b>Order Example JT2-ST-2-6.0 x 140</b>		



ETA-07/0013  
See Page 5

## EJOT Dabo® stainless steel fasteners

EJOT Dabo® TKE fasteners are manufactured from A4 austenitic stainless steel with a hardened carbon steel drill point with a passivated zinc coating for accurate drilling and tapping. For certain heavy duty applications the EJOT JT3-ST2-6.0 fastener provides an A2 austenitic stainless steel option.

### EJOT Dabo® TKE A4 stainless steel bi-metallic fastener



**High quality A4 grade stainless steel**

A4 austenitic stainless steel fastener with carbon steel drill point.

**Application**

Insulation and single layer waterproof membrane.

0.7mm to 1.2mm steel or plywood deck.

N.B. The TKE 4.8 x 50 is fully threaded only.

See washer compatibility on pages 4 and 5.

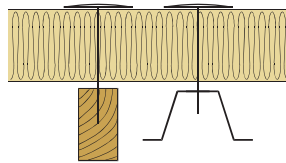

**Drive Tool**

P2 Recess

Ø x L (mm)	Deck Type				Min Qty		
	Steel Min	Insulation	Max	Plywood Min		Insulation	Max
4.8 x 50	05	-	30	5	-	10	100
4.8 x 60	15	-	30	10	-	20	100
4.8 x 70	25	-	50	20	-	30	100
4.8 x 80	35	-	60	30	-	40	100
4.8 x 90	45	-	70	40	-	50	100
4.8 x 100	55	-	80	50	-	60	100
4.8 x 120	75	-	100	70	-	80	100
4.8 x 140	95	-	120	90	-	100	100
4.8 x 160	115	-	140	110	-	120	100
4.8 x 180	133	-	160	130	-	140	100
4.8 x 200	155	-	180	150	-	160	100

Order Example TKE-4.8 x 100



ETA-07/0013  
See Page 5

### EJOT® JT3-ST2-6.0 A2 stainless steel bi-metallic fastener

**NEW TO RANGE**



**High quality A2 grade stainless steel**

A2 austenitic stainless steel fastener with carbon steel drill point.

**Application**

Heavy duty solution for higher load requirements.

For fixing insulation and membrane to 0.7mm to 1.6mm steel or plywood decks.



**Tube-washer compatibility**

This fastener is used in conjunction with the EJOT EcoTek tube-washer for its higher strength capability.

See washer compatibility on pages 4 and 5.

Call EJOT Technical for specific application guidance.

**Drive Tool**

T25 Recess

Ø x L (mm)	Order description	Min Qty
6.0 x 35	JT3-ST-2-6.0 x 35	100
6.0 x 60	JT3-ST-2-6.0 x 60	100
6.0 x 80	JT3-ST-2-6.0 x 80	100
6.0 x 100	JT3-ST-2-6.0 x 100	100
6.0 x 120	JT3-ST-2-6.0 x 120	100
6.0 x 140	JT3-ST-2-6.0 x 140	100
6.0 x 160	JT3-ST-2-6.0 x 160	100
6.0 x 180	JT3-ST-2-6.0 x 180	100
6.0 x 200	JT3-ST-2-6.0 x 200	100

Order Example JT3-ST-2-6.0 x 80



ETA-07/0013  
See Page 5

## EJOT Time-saving products

Introducing three bright new innovations from EJOT, each designed to save valuable time, eliminate unnecessary labour - and make the installation process easier from start to finish.

Scan here to watch our short guide on all of these time saving products.



### EJOT® easy reach 'Pouch Bag'

Adds efficiency and speed to installation. Provides easy access to your pre-assembled fastener / washer combinations.

#### Application information

- Waterproof robust material.
- Hip belt with plastic buckle.
- Holds up to 500 fasteners.
- At-a-glance scale for instant combination-length identification.

Order description: EJOT Pouch Bag



### EJOT® M6 x 600mm extension bar



Simplicity in a 'click'. Install straight from bag to deck in no time - no bending!

#### Application information

For easy and comfortable installation of TKR / TKE fasteners, pre-assembled with the HTK 50 2G tube-washer.

Spring pin with clamping function.

Simply slide on the flat roof fasteners.

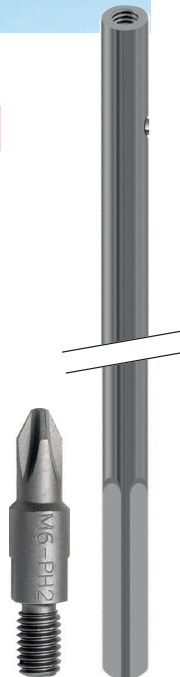

### Pre-assembled and ready to install

Order HTK 2G 50 tube-washers pre-assembled with TKR flat roofing fasteners, for significant on site time-savings.



M6 x 600mm Extension bar		
Size	Length	Order Description
M6	600mm	Bit extension with spring pin M6 x 600

M6 Threaded Drive bits		
Type	Length	Order Description
PH2	35mm	PH2-M6 x 35
T25	33mm	TX25-M6 x 33
T30	33mm	TX30-M6 x 33



# TKR carbon steel fastener + HTK 2G 50 combination

TKR carbon steel fastener / HTK 2G 50 tube-washer



**NEW**



HTK 2G Plug available for liquid applied systems.

**ASK FOR DETAILS.**

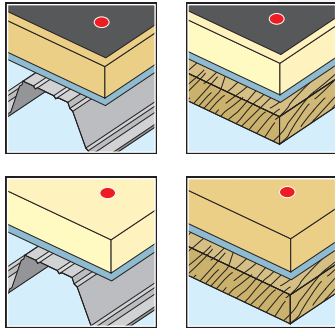

**Application**

Insulation and single layer waterproof membrane back to 0.7mm to 1.2mm steel deck.

Insulation and single layer waterproof membrane to plywood deck a minimum of 18mm in thickness.

Thermally broken fastener/washer combination for minimal cold bridging.

**Tube-washer detail**

For HTK 2G 50 tube-washer detail and material specification - see page 7.

**Fastener detail**

For TKR carbon fastener application detail and material specification - please see page 8.

**Drive Tool**

 **P2 Recess**

Drive Bit size and lengths are shown in the table to the right.

 | ETA-07/0013  
See Page 5

 | See Page 5

**Recommended combinations:**

Using the guide below, read across to match insulation depth to length of HTK tube-washer and correct combination of TKR fastener.

Insulation Thickness	HTK Length	TKR Length - Steel Deck	TKR Length - Plywood Deck	Drive Bit	Min Qty
30	15	35	60	P2 100mm	100
40	15	50	70	P2 100mm	100
50	15	60	80	P2 100mm	100
60	35	50	70	P2 100mm	100
70	35	60	80	P2 100mm	100
80	55	50	70	P2 100mm	100
90	55	60	80	P2 100mm	100
100	55	70	90	P2 100mm	100
110	55	80	60	P2 100mm	100
120	95	50	70	P2 150mm	100
130	95	60	80	P2 150mm	100
140	95	70	90	P2 150mm	100
150	95	80	100	P2 150mm	100
160	95	90	110	P2 150mm	100
170	145	50	70	P2 200mm	100
180	145	60	80	P2 200mm	100
190	145	70	90	P2 200mm	100
200	145	80	100	P2 200mm	100
210	185	50	70	P2 250mm	100
220	185	60	80	P2 250mm	100
230	185	70	90	P2 250mm	100
240	185	80	100	P2 250mm	100
250	225	50	70	P2 300mm	100
260	225	60	80	P2 300mm	100
270	225	70	90	P2 300mm	100
280	225	80	100	P2 300mm	100
290	225	90	110	P2 300mm	100
300	275	50	60	P2 350mm	100
310	275	60	70	P2 350mm	100
320	275	70	80	P2 350mm	100
330	275	80	90	P2 350mm	100
340	275	90	60	P2 350mm	100
350	325	50	70	P2 350mm	100
360	325	60	80	P2 350mm	100
370	325	70	90	P2 350mm	100
380	325	80	100	P2 350mm	100
390	325	90	110	P2 350mm	100
400	325	100	120	P2 350mm	100

All table measurements in mm



**Higher loading option**

Where increased resistance is required for unusually high load applications, the EcoTek® T-50 tube-washer offers a compatible super-strength solution - see Page 7.

# TKE stainless steel fastener + HTK 2G 50 combination

TKE A4 grade stainless steel fastener / HTK 2G 50 tube-washer



**NEW**

HTK 2G Plug available for liquid applied systems.

**ASK FOR DETAILS.**

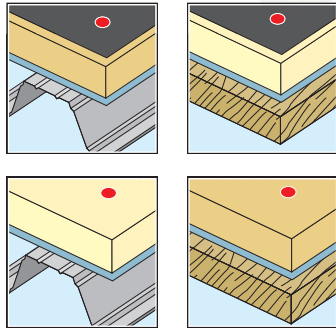

### Application

Insulation and single layer waterproof membrane back to 0.7mm to 1.2mm steel deck.

Insulation and single layer waterproof membrane to plywood deck a minimum of 18mm in thickness.

Thermally broken fastener/washer combination for minimal cold bridging.

### Tube-washer detail

For HTK 2G 50 tube-washer detail and material specification - see page 7.

### Fastener detail

For TKE stainless steel fastener application detail and material specification - see page 10.

### Drive Tool



Drive Bit size and lengths are shown in the table to the right.



ETA-07/0013  
See Page 5



See Page 5



### Recommended combinations:

Using the guide below, read across to match insulation depth to length of HTK tube-washer and correct combination of TKE fastener.

Insulation Thickness	HTK Length	TKE Length - Steel Deck	TKE Length - Plywood Deck	Drive Bit	Min Qty
30	15	50	60	P2 100mm	100
40	15	50	70	P2 100mm	100
50	15	60	80	P2 100mm	100
60	35	50	70	P2 100mm	100
70	35	60	80	P2 100mm	100
80	55	50	70	P2 100mm	100
90	55	60	80	P2 100mm	100
100	55	70	90	P2 100mm	100
110	55	80	60	P2 100mm	100
120	95	50	70	P2 150mm	100
130	95	60	80	P2 150mm	100
140	95	70	90	P2 150mm	100
150	95	80	100	P2 150mm	100
160	95	90	100	P2 150mm	100
170	145	50	70	P2 200mm	100
180	145	60	80	P2 200mm	100
190	145	70	90	P2 200mm	100
200	145	80	100	P2 200mm	100
210	145	90	70	P2 200mm	100
220	145	100	80	P2 200mm	100
230	185	70	90	P2 250mm	100
240	185	80	100	P2 250mm	100
250	225	50	70	P2 300mm	100
260	225	60	80	P2 300mm	100
270	225	70	90	P2 300mm	100
280	225	80	100	P2 300mm	100
290	225	90	100	P2 300mm	100
300	275	50	60	P2 350mm	100
310	275	60	70	P2 350mm	100
320	275	70	80	P2 350mm	100
330	275	80	90	P2 350mm	100
340	275	90	60	P2 350mm	100
350	325	50	70	P2 350mm	100
360	325	60	80	P2 350mm	100
370	325	70	90	P2 350mm	100
380	325	80	100	P2 350mm	100
390	325	90	100	P2 350mm	100
400	325	100	120	P2 350mm	100

All table measurements in mm



### Higher loading option

Where increased resistance is required for unusually high load applications, the EcoTek® T-50 tube-washer offers a compatible super-strength solution - see Page 7.

# JT2 ST-2-6.0 carbon steel fastener + EcoTek washer

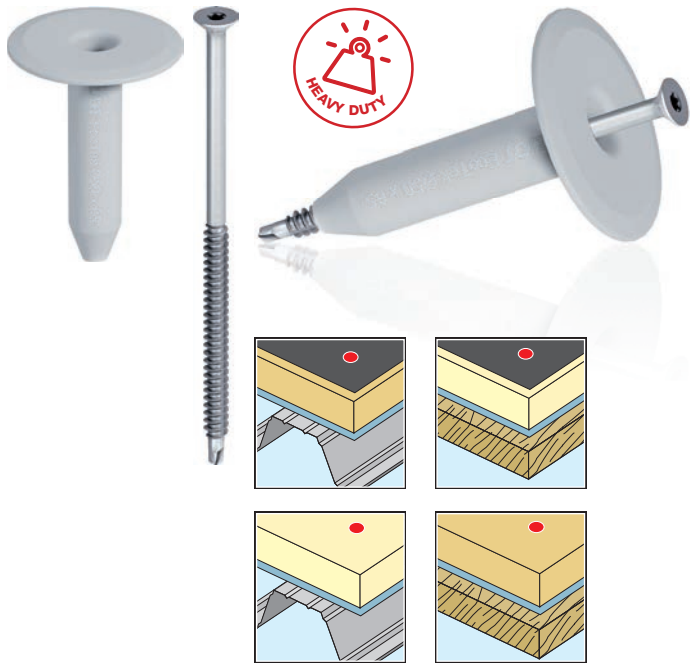

**NEW TO RANGE**

**High quality carbon steel: BS EN ISO 10666**

Case-hardened steel with EJOGuard coating for enhanced corrosion resistance, conforming to DIN 50018.

**Application**

Heavy duty solution for higher load requirements.  
For fixing insulation and membrane to 0.7mm to 1.6mm steel or plywood decks.

**Tube-washer compatibility**

This fastener is used in conjunction with the EJOT EcoTek tube-washer for its higher strength capability.  
Call EJOT Technical for specific application guidance.

**Tube-washer detail**

For EcoTek tube-washer detail and material specification - see page 7.

**Fastener detail**

For JT2 ST-2-6.0 carbon fastener application detail and material specification - please see page 9.

**Drive Tool**



Drive Bit size and lengths are shown in the table to the right.



**Recommended combinations:**

Using the guide below, read across to match insulation depth to length of EcoTek washer and correct combination of JT2-ST-2 fastener.

Insulation Thickness (mm)	EcoTek Length	Steel Deck JT2-ST-2 Length	Plywood JT2-ST-2 Length	Min Qty
40	35	40	60	100
50	35	60	80	100
60	35	60	80	100
70	35	80	100	100
80	65	60	80	100
90	65	60	80	100
100	65	80	100	100
110	65	80	100	100
120	105	60	80	100
130	105	60	80	100
140	105	80	100	100
150	105	80	100	100
160	105	100	120	100
170	105	100	120	100
180	135	80	100	100
190	165	60	80	100
200	135	100	120	100
210	165	80	100	100
220	195	60	80	100
230	165	100	120	100
240	195	80	100	100
250	225	60	80	100
260	195	100	120	100
270	225	80	100	100
280	195	120	140	100
290	225	100	120	100
300	275	60	80	100
310	225	120	140	100
320	275	80	100	100
330	225	140	160	100
340	275	100	120	100
350	275	120	140	100

All table measurements in mm



**Higher loading option**

Where increased resistance is required for unusually high load applications, the EcoTek® T-50 tube-washer offers a compatible super-strength solution - see Page 7.

# JT3 ST-2-6.0 stainless steel fastener + EcoTek washer

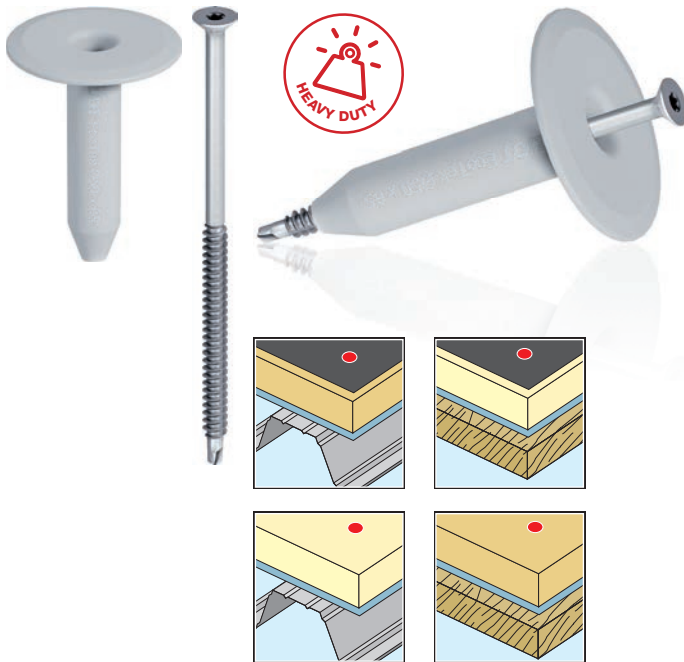

### High quality stainless steel

A2 austenitic stainless steel fastener with carbon steel drill point.

### Application

Heavy Duty Solution for higher load requirements.

For fixing insulation and membrane to 0.7mm to 1.6mm steel or plywood decks.

### Tube-washer compatibility

This fastener is used in conjunction with the EJOT EcoTek tube-washer for its higher strength capability.

Call EJOT Technical for specific application guidance.

### Tube-washer detail

For EcoTek tube-washer detail and material specification - see page 7.

### Fastener detail

For JT3 ST-2-6.0 stainless steel fastener application detail and material specification - please see page 10.

### Drive Tool



Drive Bit size and lengths are shown in the table to the right.



ETA-07/0013  
See Page 5



See Page 5

### Recommended combinations:

Using the guide below, read across to match insulation depth to length of EcoTek washer and correct combination of JT3-ST-2 fastener.

Insulation Thickness (mm)	EcoTek Length	Steel Deck JT3-ST-2 Length	Plywood JT2-ST-2 Length	Min Qty
40	35	35	60	100
50	35	60	80	100
60	35	60	80	100
70	35	80	100	100
80	65	60	80	100
90	65	60	80	100
100	65	80	100	100
110	65	80	100	100
120	105	60	80	100
130	105	60	80	100
140	105	80	100	100
150	105	80	100	100
160	105	100	120	100
170	105	100	120	100
180	135	80	100	100
190	165	60	80	100
200	135	100	120	100
210	165	80	100	100
220	195	60	80	100
230	165	100	120	100
240	195	80	100	100
250	225	60	80	100
260	195	100	120	100
270	225	80	100	100
280	195	120	140	100
290	225	100	120	100
300	275	60	80	100
310	225	120	140	100
320	275	80	100	100
330	225	140	160	100
340	275	100	120	100
350	275	120	140	100

All table measurements in mm



### Higher loading option

Where increased resistance is required for unusually high load applications, the EcoTek® T-50 tube-washer offers a compatible super-strength solution - see Page 7.

## Fasteners for concrete decks

Manufactured from case-hardened carbon steel with a Climadur organic corrosion-resistant finish, FBS-R and JBS-R fasteners combine with the EJOT EcoTek tube-washer to provide fast and secure mechanical fixing of insulation and single ply membrane back to concrete decks. Fastener can be purchased separately.

### EJOT® FBS-R case-hardened carbon steel for concrete decks



**Features**

- Combines with the EcoTek tube-washer for fixing flat roofing insulation.
- Can be combined with EJOT's metal washers and stress plates if required.
- Twin threads reduce installation torque.
- Wide range of lengths available.
- Manufactured from case-hardened carbon steel.
- Climadur coated for corrosion protection.
- See washer compatibility on pages 4 and 5.

**Drive Tool**



O x L (mm)	Embedment-Min-EMB-Max	Hole Dia (mm)	Clamping Thickness-Min-ECT-Max	Min Qty
6.3 x 35	30 - 45	5	0 - 5	100
6.3 x 60	30 - 45	5	15 - 30	100
6.3 x 70	30 - 45	5	25 - 40	100
6.3 x 80	30 - 45	5	35 - 50	100
6.3 x 100	30 - 45	5	55 - 70	100
6.3 x 120	30 - 45	5	75 - 90	100
6.3 x 140	30 - 45	5	95 - 110	100
6.3 x 160	30 - 45	5	115 - 130	100
6.3 x 180	30 - 45	5	135 - 150	100
6.3 x 220	30 - 45	5	175 - 190	100
6.3 x 260	30 - 45	5	215 - 230	100
6.3 x 300	30 - 45	5	255 - 270	100

Order Example: FBS-R 6.3 x 60

ECT - Effective Clamping Thickness



ETA-07/0013  
See Page 5

### EJOT® JBS-R 7.5 case-hardened carbon steel for concrete decks



**Features**

- To fix roofing membranes to concrete substructures.
- For combination with EJOT stress plate EcoTek 50.
- Case-hardened steel.
- Climadur coated for corrosion.
- See washer compatibility on pages 4 and 5.

**Drive Tool**



O x L (mm)	Embedment-Min-EMB-Max	Hole Dia (mm)	Clamping Thickness-Min-ECT-Max	Min Qty
JBS-R 7.5 x 80	30 - 45	6	35 - 50	100
JBS-R 7.5 x 120	30 - 45	6	75 - 90	100
JBS-R 7.5 x 150	30 - 45	6	105 - 120	100
JBS-R 7.5 x 210	30 - 45	6	165 - 180	100
JBS-R 7.5 x 300	30 - 45	6	255 - 270	100

Order Example: JBS-R 7.5 x 150

ECT - Effective Clamping Thickness



ETA-07/0013  
See Page 5



## FPS-E fasteners for aerated concrete decks

Manufactured from grade A2 austenitic stainless steel, FPS-E fasteners are ideally suited to mechanically fixing insulation and waterproof membranes to aerated concrete as EAD reference below (see EJOT Technical Services). Also available as a separate purchase.

### EJOT® FPS-E A2 austenitic stainless steel for aerated concrete decks



**Features**

- Combines with the EcoTek tube-washer for fixing flat roofing insulation.
- No pre-drilling required.
- Fast and reliable fixing into aerated concrete.
- Fully approved according to ETAG 006, ETA-07/0013.
- Manufactured from corrosion resistant A2 austenitic stainless steel.
- See washer compatibility on pages 4 and 5.

**Drive Tool**



Ø x L (mm)	Embedment-Min-EMB-Max	Hole Dia (mm)	Clamping Thickness-Min-ECT-Max	Min Qty
8.0 x 80	60 - 70	Not required	10 - 20	100
8.0 x 100	60 - 70	Not required	30 - 40	100
8.0 x 120	60 - 70	Not required	50 - 60	100
8.0 x 140	60 - 70	Not required	70 - 80	100
8.0 x 160	60 - 70	Not required	90 - 100	100
8.0 x 180	60 - 70	Not required	110 - 120	100
8.0 x 200	60 - 70	Not required	130 - 140	100
8.0 x 220	60 - 70	Not required	150 - 160	100
8.0 x 240	60 - 70	Not required	170 - 180	100
8.0 x 260	60 - 70	Not required	190 - 200	100
8.0 x 280	60 - 70	Not required	210 - 220	100
8.0 x 300	60 - 70	Not required	230 - 240	100

Order Example: FPS-E 8.0 x 100

ECT - Effective Clamping Thickness



ETA-07/0013  
See Page 5



### EJOT Technical Services

When fixing back to a concrete deck EJOT recommends that a pull out test is carried out by our site technician or one of our regional sales engineers.

For applications where substrates may have an unknown carrying capacity, we provide on-site pull-out testing, meeting the requirements of EAD 030351-00-0402.

Where material specification should consider special environmental conditions, please call our technical team on **01977 687040**



## EcoTek tube-washer + FBS-R carbon steel fastener

FBS-R fasteners are manufactured in carbon steel with a resistant Climadur organic coated finish. Membrane and insulation back to concrete decks.



EcoTek - 50 x L

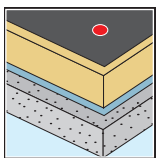

FBS-R 6.3 x L

### Features

**Fastener combination:**  
Refer to table

**Minimum embedment:**  
30mm

**Hole depth\*:**  
45mm

**Hole diameter:**  
5.0mm

**Anchor system:**  
EcoTek and FBS-R

**Deck:**  
Concrete

\*Hole depth is for guidance, please allow for site to site variations and tolerances

### Drive Tool



ETA-07/0013  
See Page 5



See Page 5

Insulation Thickness	EcoTek Length	FBS-R Length
50	50 x 35	60
60	50 x 35	70
70	50 x 35	80
80	50 x 65	60
90	50 x 65	70
100	50 x 85	60
110	50 x 85	70
120	50 x 85	80
130	50 x 105	70
140	50 x 105	80
150	50 x 135	60
160	50 x 105	100
170	50 x 135	80
180	50 x 105	120
190	50 x 135	100
200	50 x 165	80
210	50 x 135	120
220	50 x 165	100
230	50 x 195	80
240	50 x 165	120
250	50 x 195	100
260	50 x 225	80
270	50 x 195	120
280	50 x 225	100
290	50 x 275	60
300	50 x 225	120
310	50 x 275	80
320	50 x 225	140
330	50 x 275	100
340	50 x 225	160
350	50 x 275	120
360	50 x 225	180



### Higher loading option

Where increased resistance is required for unusually high load applications, the EcoTek® T-50 tube-washer offers a compatible super-strength solution - see Page 7.

## EcoTek tube-washer + FPS-E stainless steel fastener

FPS-E fasteners are manufactured from A2 austenitic stainless steel.

Membrane and insulation back to aerated concrete decks.



EcoTek - 50 x L



FPS-E 8.0 x L

### Features

**Fastener combination:**  
Refer to table

**Minimum embedment:**  
60mm

**Anchor system:**  
EcoTek and FPS-E

**Deck:**  
Aerated concrete  
No pilot hole required

### Drive Tool



Several different combinations of these products are available. Due to the inconsistency of aerated materials EJOT recommends you contact our technical department for advice. In addition, we recommended a pull out test is conducted.

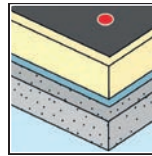

ETA-07/0013  
See Page 5



### Higher loading option

Where increased resistance is required for unusually high load applications, the EcoTek® T-50 tube-washer offers a compatible super-strength solution - see Page 7.

## EJOT® FDD plus 50

For fixing roofing membranes and insulation to all common lightweight and aerated concrete substrates.

The new EJOT® flat roofing anchor FDD-Plus-50 is available in total lengths from 95mm up to 535mm.

This product only comes pre-assembled. The standard version of the anchor fastener is organically coated and meets highest demands on corrosion protection.

\*For renovations, a stainless steel version is also available.



### Application area

- To secure roofing membrane
- Ideal for pitched and tapered roof insulation
- For concrete, lightweight concrete and aerated concrete substrates
- Limits cold bridging

### Properties

- Anchor sleeve made of high-grade plastic material
- Anchor fastener is manufactured in a choice of A2 stainless steel or carbon steel with high-quality Climadur organic coating (15 Kesternich cycles, DIN 50018).

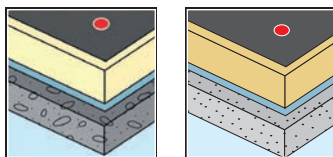

### Drive Tool



Ø washer (mm)	Ø pilot hole (mm)	Anchor Length (mm)	Substructure 1 total panel thickness	Substructure 2 total panel thickness	Min Qty
50*	8	95*	65*	30*	100*
50	8	115	85	50	100
50	8	135	105	70	100
50	8	155	125	90	100
50	8	175	145	110	100
50	8	195	165	130	100
50	8	215	185	150	100
50	8	235	205	170	100
50	8	255	225	190	100
50	8	275	245	210	100
50	8	295	265	230	100
50	8	335	305	270	100
50	8	375	345	310	100
50	8	415	385	350	100
50	8	455	425	390	100
50	8	495	465	430	100
50	8	535	505	470	100

Substrate 1: Concrete C12/12; lightweight concrete LC12/13  
Substrate 2: Aerated concrete P3.3

**Order Example: FDD-Plus-50 x 155-R**  
(R = Anchors + carbon steel fastener with resistant organic finish)  
**FDD-Plus-50 x 155-E**  
(E = Anchors + austenitic stainless steel fastener)

For applications where stainless steel is specified (i.e. renovation projects) pull-out tests should be arranged with our service team for all renovation cases.



ETA-07/0013  
See Page 5

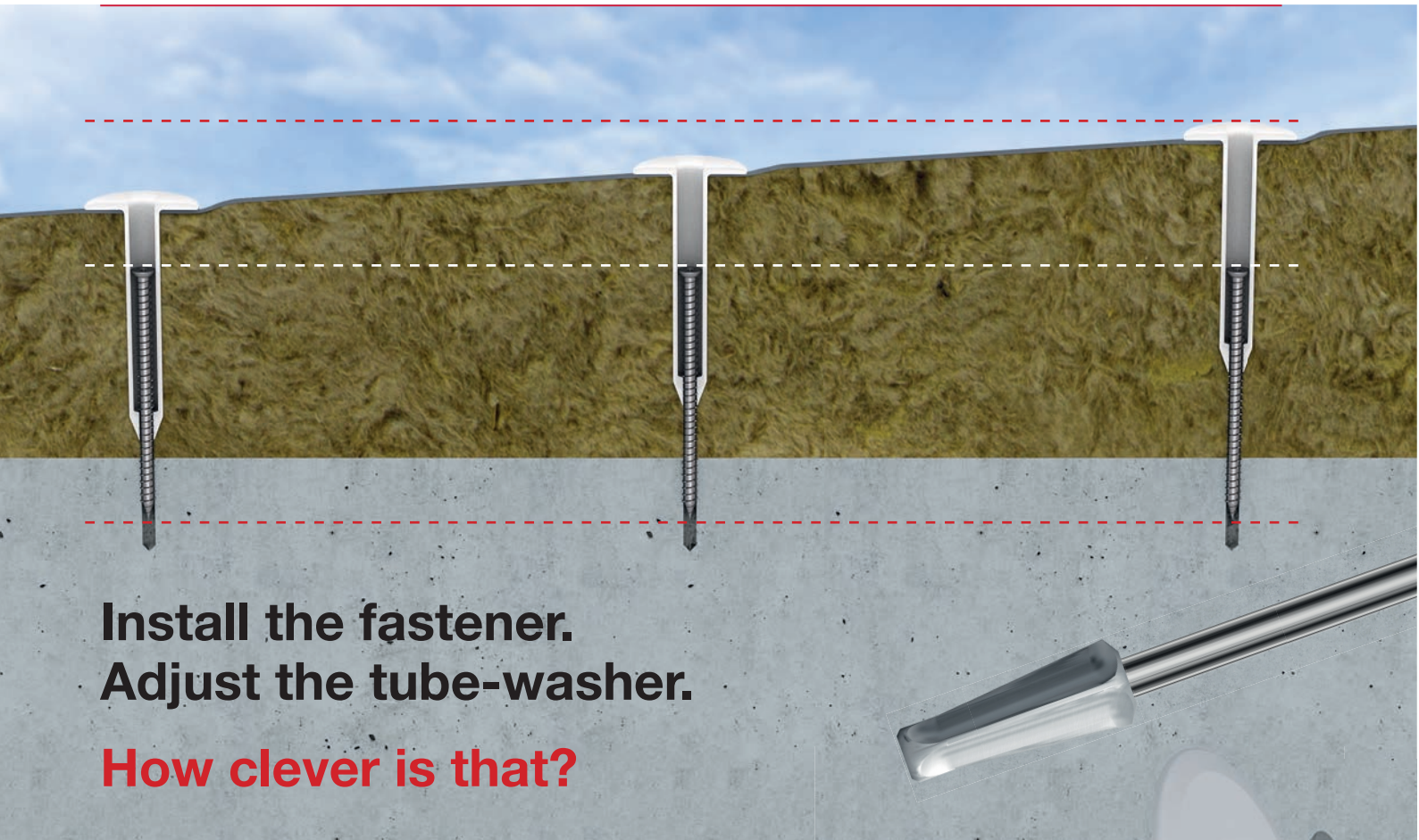

**Install the fastener.  
Adjust the tube-washer.  
How clever is that?**

**EcoTek tube-washer + NEW TO RANGE  
JBS-R carbon steel fastener  
For tapered roof systems**

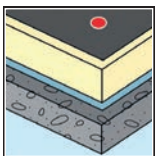
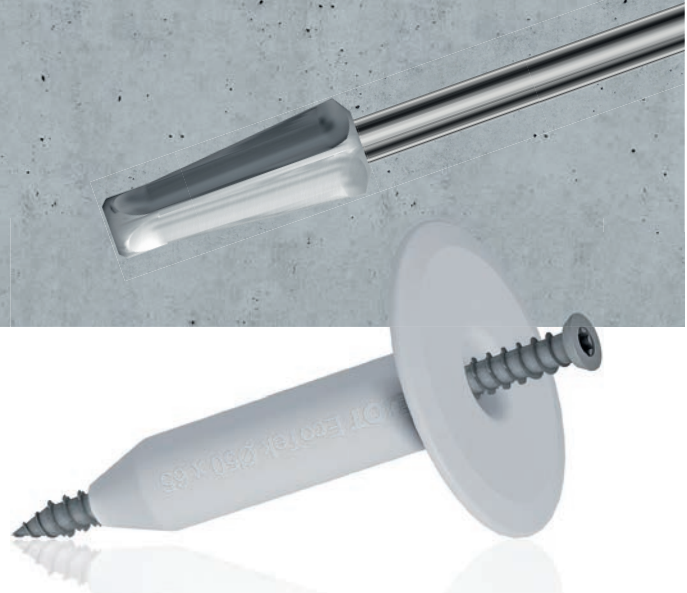

Rarely are flat roof installations completely flat. Most have a slight slope to allow rainwater to drain in a pre-determined direction. Where a tapered system is being deployed, the standard installation practice is to use different length fasteners to correspond with the variations of insulation thicknesses along the slope.

Now, EJOT has developed an innovative new installation system where the EcoTek tube-washer combines with the JBS-R 7.5 fastener. The result is mechanical installation for tapered systems, that saves time, reduces combination headaches and delivers year-round practicality.



**Application range**

For fixing membrane and insulation back to concrete decks, notably tapered systems. EJOT's JBS-R 7.5 fasteners are manufactured in carbon steel with a resistant organic finish. Innovative tooling options make insulation depths from 70mm to 500mm a pleasure to install, whatever the weather.



**Higher loading option**

Where increased resistance is required for unusually high load applications, the EcoTek® T-50 tube-washer offers a compatible super-strength solution - see Page 7.

## EJOT® concrete fastener JBS-R + EcoTek (pre-assembled)



### Application range

Adjustable fastening element.  
Ideal for tapered systems.  
To fix roofing membranes with insulation to concrete substructures.

### Properties

Fastener: Case-hardened steel;  
Climadur coated – high-quality coating to improve corrosion protection (15 Kesternich cycles, DIN 50018).

Tube-washer: high-grade plastic material.

Order description	Insulation Thickness	Effective recess tube length (mm)	Fastener length (mm)	Min Qty
JBS-R/EcoTek-70-100-65/80	70 - 100	55	80	100
JBS-R/EcoTek-90-120-85/80	90 - 120	75	80	100
JBS-R/EcoTek-110-180-105/120	110 - 180	95	120	100
JBS-R/EcoTek-170-270-165/150	170 - 270	155	150	100
JBS-R/EcoTek-230-390-225/210	230 - 390	215	210	100
JBS-R/EcoTek-340-500-335/210	340 - 500	325	210	100
JBS-R/EcoTek 430-590-335/300	430 - 590	325	300	100

### Note

Pull-out tests can be arranged with our service team for all renovation projects.

### JBS-R/EcoTek-70-100-65/80

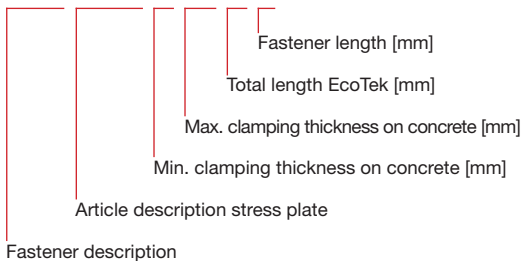

### Technical specifications

Hole diameter	6mm
Embedment depth	≥ 30mm
Min. drill hole depth	≥ 35mm
Drive fastener	Hexalobular TX30
Drive EcoTek	EcoTek Tool

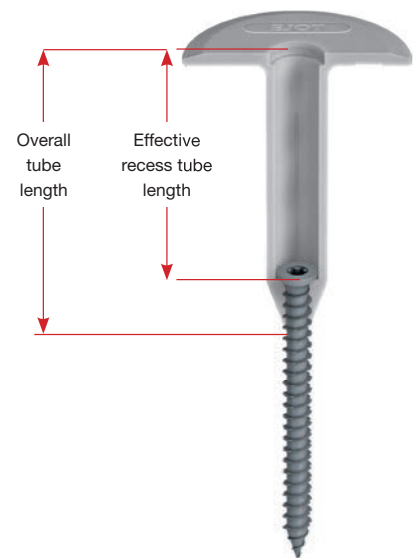
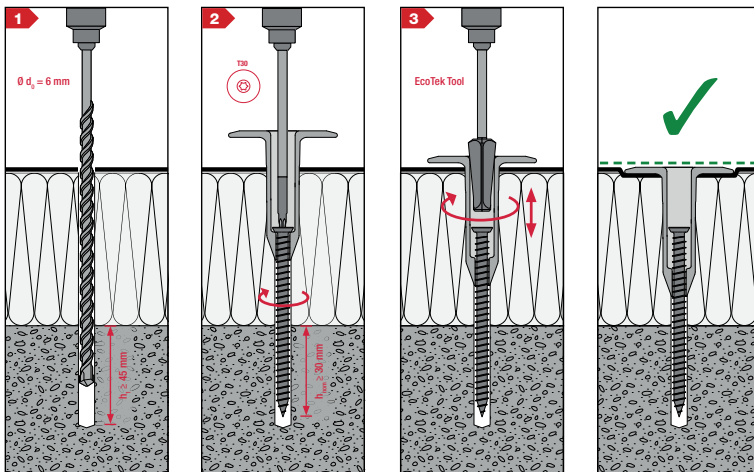
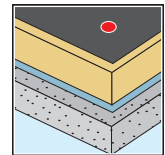

This QR code takes you straight to our tapered roofing video.

Subscribe to our EJOT UK YouTube channel to see all of our videos.



# Tooling for installations into concrete decks



## 1 EJOT® SDS drill bits

### Standard drilling option



Working length	Diameter	Order Description
50mm	5.0mm	SDS plus 5.0 x 110/50
100mm	5.0mm	SDS plus 5.0 x 160/100
150mm	5.0mm	SDS plus 5.0 x 210/150
250mm	5.0mm	SDS plus 5.0 x 310/250
100mm	6.0mm	SDS plus 6.0 x 160/100
150mm	6.0mm	SDS plus 6.0 x 210/150
200mm	6.0mm	SDS plus 6.0 x 260/200
100mm	8.0mm	SDS plus 8.0 x 160/100
150mm	8.0mm	SDS plus 8.0 x 210/150
200mm	8.0mm	SDS plus 8.0 x 260/200

### Application information

- For drilling concrete with fast dust removal.
- Fits direct into SDS drilling machines.

## 2 EJOT® TX30 drive bar

### High performance fastener installation



TX30 One Piece Drive Bar		
Drive: 1/4" hexagon DIN/ISO 1173 - E 6.3		
Size	Length	Order Description
TX30	200mm	TX30 - 1/4"/E x 200
TX30	350mm	TX30 - 1/4"/E x 350

### Application information

- For comfortable driving of installation fasteners.

## 1 EJOT® 'A Cone'

### 'Installer standing' hammer drill option combines with extension bar (4)



Total length	Effective length	Diameter	Order Description
160mm	100mm	5.0mm	Hammer drill A cone 5 x 160
160mm	100mm	6.0mm	Hammer drill A cone 6 x 160

### Application information

- For drilling concrete from a standing position.

## 3 EJOT® complete EcoTek tool

### Innovative one-piece adjustment tool for EcoTek JBS-R combination



Drive	Order Description
1/4" hexagon DIN/ISO 1173 - E 6.3	Complete EcoTek Tool

### Application information

- Adjustment tool for the usage of the concrete fastener JBS-R in combination with the EcoTek 50 tube-washer.
- Easy handling.
- Optimal installation depth of the EcoTek 50.

## 1 EJOT® 'A Cone' + flange

### 'Installer standing' hammer drill option combines with extension bar (4)



Total length	Effective length	Diameter	Order Description
102mm	35mm	5.0mm	Hammer drill A cone 5 x 102/35
102mm	35mm	6.0mm	Hammer drill A cone 6 x 102/35

### Application information

- For drilling concrete from a standing position.
- Exact depth control and precise penetration of insulations.

## 4 EJOT® drill extension

### Combines with 'A Cone' / 'A Cone' + flange



Total length	Order Description
500mm	Drill bit extension SDS 500mm
	EJOT drill spare parts kit (3 x triangular release wedges)

### Application information

- For hammer drill A cone.
- For hammer drill A cone + flange.
- Drive SDS Plus.



## Deck fixings and fasteners

### EJOT LS



**Application**

Steel deck 0.7mm to 1.2mm in thickness into light steel sections from 1.2mm to 3.0mm in thickness.

Carbon steel with organic corrosion resistance finish used washed or unwashed.

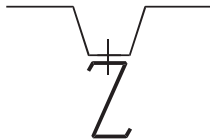

**Drive Tool**



Ø x L (mm)	Unwashed		Min Qty
	Min	ECT Max	
5.5 x 25	1.2 - 8.0		100
5.5 x 32	1.2 - 13.0		100

**Order Example Unwashed: LS 5.5 x 25**  
**Order Example Washed: LS 5.5 x 25 A15**

ECT - Effective Clamping Thickness

### EJOT HS



**Application**

Steel deck 0.7mm to 1.2mm in thickness into heavy steel sections from 4.0mm to 12.0mm in thickness.

Carbon steel with organic corrosion resistance finish used washed or unwashed.

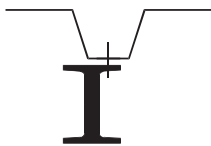

**Drive Tool**



Ø x L (mm)	Unwashed		Min Qty
	Min	ECT Max	
5.5 x 38	4.0 - 16.0		100

**Order Example Unwashed: HS 5.5 x 38**  
**Order Example Washed: HS 5.5 x 38 A15**

ECT - Effective Clamping Thickness

### EJOT TS



**Application**

Steel deck 0.7mm to 1.2mm in thickness into plywood and timber.

Mechanical performance is dependent on embedment and grade of plywood and timber.

Carbon steel with organic corrosion resistance finish used washed or unwashed.

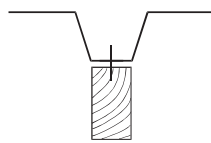

**Drive Tool**



Ø x L (mm)	Unwashed		Min Qty
	Min	ECT Max	
6.3 x 45			100
6.3 x 60			100

**Order Example Unwashed: TS 6.3 x 45**  
**Order Example Washed: TS 6.3 x 45 A15**

ECT - Effective Clamping Thickness

### EJOT® JF2-2



**Application**

For fixing laps of roofing or cladding sheets and flashings.

Carbon steel with organic corrosion resistance finish and pierce point. Used washed or unwashed.



**Drive Tool**



Ø x L (mm)	Min ECT Max		Min Qty
	Min	Max	
5.5 x 25	0.5 - 10.0		100

**Order Example Unwashed: JF2-2 5.5 x 25**  
**Order Example Washed: JF2-2 5.5 x 25 A15**

ECT - Effective Clamping Thickness

## Specialist fastener for aluminium decking

### EJOT Dabo® VHT-E-4.8 fastener NEW TO RANGE

Grade A4 stainless steel with hardened carbon steel pierce point



**Application**

Insulation and single layer waterproof membrane onto:  
 0.8mm, 1.0mm, 1.2mm aluminium sheets.  
 0.5mm, 0.7mm steel sheets.  
 Plywood decks.

**Features**

Incorporates 100.0mm of thread.  
 100mm length is fully threaded.  
 Such a long thread is useful for refurbishment jobs where you do not know the overall depth of existing steel deck.  
 This screw has you covered for where trough depth of deck is ≤80.0mm.

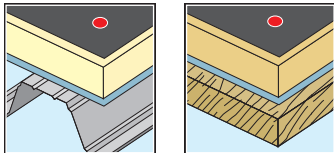

**Drive Tool**



Ø x L (mm)	Order Description	Min Qty
4.8 x 100	VHT-E-4.8 x 100	100
4.8 x 160	VHT-E-4.8 x 160	100

Order Example: VHT-E-4.8 x 100



ETA-07/0013  
 See Page 5

## Peel rivets

Aluminium body with steel mandrel

### EJOT PR



**Application**

Insulation and single layer waterproof membrane.  
 Woodwool, aluminium, thin plywood and perforated steel decks and Stramit boards.  
 The PR range can be used with the HTV 82/40 - 7 steel stress plate.  
 \*Below 19mm build-up the mandrel stub may protrude above the rivet head and may need to be cropped.  
 PR rivets are suitable for use in 50mm minimum thickness woodwool decking.  
 A site test is recommended in all woodwool decking applications.

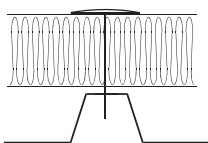

Ø x L (mm)	Insulation		Min Qty
	Pilot Hole (mm)	Max Grip Range (mm)	
6.4 x 35	6.6	25	100
6.4 x 50	6.6	40	100
6.4 x 80	6.6	70	100
6.4 x 100	6.6	90	100
6.4 x 120	6.6	110	100
6.4 x 150	6.6	140	100
6.4 x 175	6.6	165	100
6.4 x 190	6.6	180	100

Order Example: PR 6.4 x 35



## Hammer set anchor

**EJOT® ND-K** NEW TO RANGE



**Application**

Flashings, trims, capping's, peel stop and termination bars.

**Note**

Always pre-drill the hole 10mm deeper than the intended embedment.

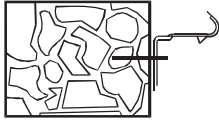

**Drive Tool**

- ✚ Hammer Set
- ✚ Use P2 recess for removal

Ø x L (mm)	Dimensions		Clamping Thickness Min ECT Max	Min Qty
	Embedment (mm)	Hole Diameter (mm)		
6 x 40 V	30	6	0 - 10	100
6 x 60 V	30	6	0 - 30	100
6 x 50 E	30	6	0 - 20	100

Order Example: ND-K-6.0 x 40-V

ECT - Effective Clamping Thickness

## Online Shop

Most EJOT products are available to buy online. Visit [www.ejot.co.uk](http://www.ejot.co.uk) to open a webshop account.

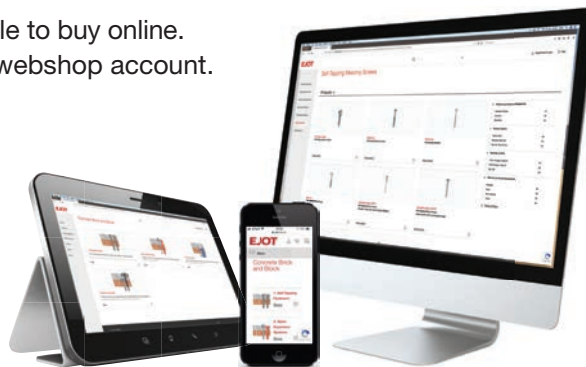

## Stress plates

Galvanised carbon steel plates for load spreading when fixing insulation

### EJOT® HTV 70 RU



**Application**

Insulation.  
Various substrates depending on fastener.  
Typical fasteners: TKR-4.8 x L, TKE-4.8 x L and F-BSR-6.3 x L.

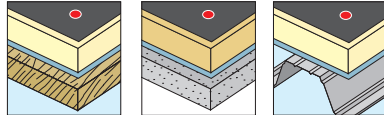

Dia (mm)	Hole Size (mm)	Min Qty
70	5.5	100
<b>Order Example: HTV-70 RU</b>		

### EJOT® HTV 40 RU

**NEW TO RANGE**



**Application**

To fix roofing membrane and to fasten pressure-resistant insulation to substructures made of trapezoidal steel profiles, timber, wood-based materials, concrete and aerated concrete.

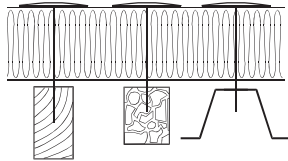

Dia (mm)	Hole Size (mm)	Min Qty
40	5.5	100
<b>Order Example: HTV-40 RU</b>		

**Typical fasteners**

TKR-4.8 x L, TKE 4.8 x L, TKR-4-4.8 x L, TKR-ZT6-5.5 x L, VHT-E- 4.8 x L, FBS-R-6.3 x L, FPS-E-8.0 x L



ETA-07/0013  
See Page 5

### EJOT® HTV RU 40 W

**NEW TO RANGE**



**Application**

To fix roofing membrane to substructures made of timber and wood-based materials (without insulation).

**Characteristics**

Stress plate: Alu-zinc coated steel.  
Fastener: Case-hardened steel; Climadur coated – high-quality coating to improve corrosion protection (15 Kesternich cycles, DIN 50018).  
Pre-assembled.

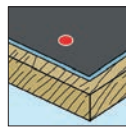

**Magnet bracket HTV-RU**

Installation tool for stress plate HTV-RU-40-W.

**Drive Tool**



Dia (mm)	Fastener Length (mm)	Min Qty
40	35	100
40	45	100
<b>Order Example: HTV-RU-40/25-W</b>		



ETA-07/0013  
See Page 5

Description	Min Qty
Magnet bracket HTV-RU	1
Bit cross recess PH2-M6 x 35	1

**EJOT® HTV 82/40TK**



**Application**

Membrane laid on rigid insulants that cannot accept a deep recess.

Typical fasteners: TKR-4.8 x L, TKE-4.8 x L, TKR-4-4.8 x L, VHT-E-4.8 x L



Ø x L (mm)	Dimensions			Min Qty
	Length (mm)	Width (mm)	Hole Size (mm)	
82/40TK	82.0	40.0	5.0	100

Order Example: HTV-82/40TK

**EJOT® HTV 82/40F**

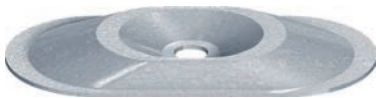

**Application**

Membrane on top of a solid substrate.

Typical fasteners: TKR-4.8 x L, TKE-4.8 x L, TKR-4-4.8 x L, TKR-ZT6-5.5 x L, VHT-E-4.8 x L, FBS-R-6.3 x L, FPS-E-8.0 x L



Ø x L (mm)	Dimensions			Min Qty
	Length (mm)	Width (mm)	Hole Size (mm)	
82/40 F	82.0	40.0	7.5	100

Order Example: HTV-82/40F

**EJOT® HTV 82/40-5 deep dimple**



**Application**

Membrane.

Typical fasteners: TKR-4.8 x L, TKE-4.8 x L, VHT-E-4.8

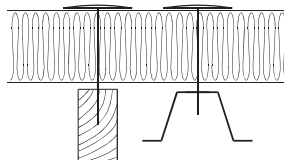

Ø x L (mm)	Dimensions			Min Qty
	Length (mm)	Width (mm)	Hole Size (mm)	
82/40	82.0	40.0	5.0	100

Order Example: HTV-82/40-5

**EJOT® HTV 82/40-7 deep dimple**



**Application**

Membrane.

Typical fasteners: TKR-ZT6-5.5 x L, FBS-R 6.3 x L, PR 6.4 x L

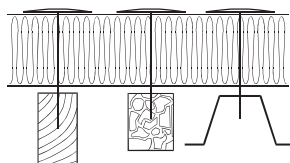

Ø x L (mm)	Dimensions			Min Qty
	Length (mm)	Width (mm)	Hole Size (mm)	
82/40-7	82.0	40.0	7.0	100

Order Example: HTV-82/40-7

## EJOT® flat roof profile FP

### Application

To fix roofing membrane most common substrates; concrete, aerated concrete, steel, aluminium, trapezoidal profile, and plywood decks.

For structural edge and parapet fastening.

Alu-zinc-coated steel.

3 different hole diameters in one profile.

Total length 2.25m.

### Note

For combination with EJOT Dabo® fasteners, concrete and aerated concrete fasteners and self-drilling fasteners. Also compatible with EJOT facade anchors according to ETA-10/0305.

Length (mm)	Width (mm)	Height Including Fold Edge (mm)	Thickness (mm)	Hole Diameter (mm)		
				for stress plates	for facade anchors	for fasteners
2.25	30	7.5	1.5	14.5	10.5	7.0

**Order Example: FP Profile Bar**



ETA-07/0013  
See Page 5

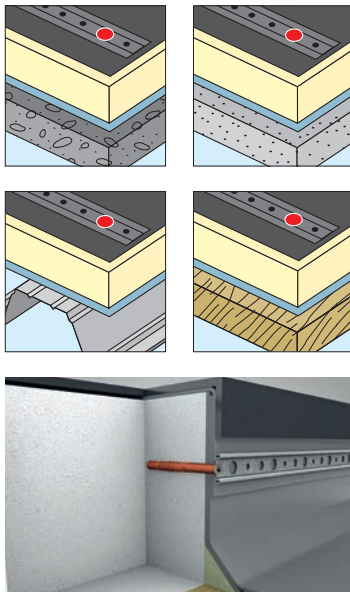

## EJOT® Stress plate HTK-S



### Application

To secure roofing membranes to substructures made of steel, trapezoidal aluminium profile, timber and wood-based material in combination with the EJOT flat roof profile FP.

To reduce thermal bridges.

For special requirements of resistance to imposed loads.

20mm diameter for specific use with flat roof profile FP.

### Characteristics

High-grade plastic material.

Telescope design for resistance to imposed loads.

### Note

For combination with EJOT Dabo® fasteners.

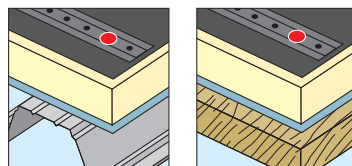

Washer (mm)	Effective Shaft Length (mm)	Order Description	Min Qty
20	90	HTK-S-20 x 90	100
20	140	HTK-S-20 x 140	100

**Order Example: HTK-S-20 x 140**



ETA-07/0013  
See Page 5

## EJOT® HTK 2G 75mm diameter tube-washer

Correct mechanical fixing of insulation where membrane will be adhered.



Where installers prefer to mechanically fixed insulation to the deck but adhere the waterproofing membrane, EJOT has developed a unique 75mm diameter tube-washer to meet SPRA guidelines for part-mechanical / part-adhered hybrid installations.

Made to the same exacting standards as its 50mm counterpart, the HTK 2G 75 tube-washer expands our range to the most complete from any single manufacturer.

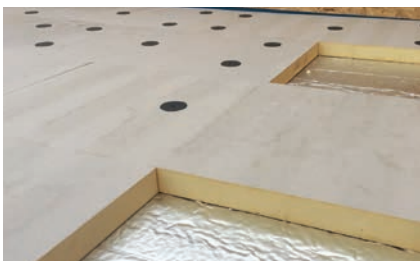

- 75mm diameter tube-washer for steel and plywood decks.
- Manufactured specifically for part-adhered installations.
- Meets SPRA guidelines for part-adhered installations.
- Combines with EJOT Dabo® TKR and TKE fasteners.
- High quality polyethylene material.
- Telescope design for resistance to imposed loads.
- Helps to limit cold bridging.



Developed in accordance with the SPRA Design Guide for Single Ply Roofing

**TUBE-WASHER DETAIL**  
For HTK 2G 75  
tube-washer detail and  
material specification -  
see page 7.

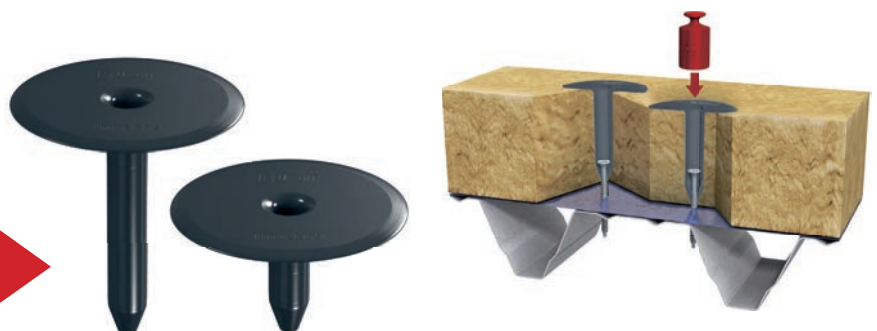

# TKR carbon steel fastener + HTK 2G 75 combination

HTK 2G 75 tube-washer / TKR carbon steel fastener

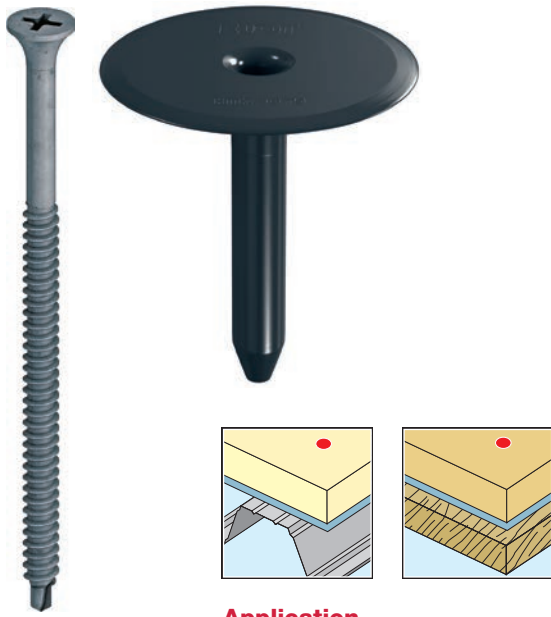

TKR

**Application**

Insulation back to 0.7mm to 1.2mm steel deck  
 Insulation to plywood deck a minimum of 18mm in thickness  
 Thermally broken fastener/washer combination for minimal cold bridging

**Tube-washer detail**

For HTK 2G 75 tube-washer detail and material specification - see page 7.

**Fastener detail**

For TKR carbon fastener application detail and material specification - please see page 8.

**Recommended combinations:**

Using the guide below, read across to match insulation depth to length of HTK tube-washer and correct combination of TKR fastener.

Insulation Thickness	HTK Length	TKR Length - Steel Deck	TKR Length - Plywood Deck	Drive Bit	Min Qty
60	35	50	70	P2 100mm	100
70	35	60	80	P2 100mm	100
80	55	50	70	P2 100mm	100
90	55	60	80	P2 100mm	100
100	55	70	90	P2 100mm	100
110	55	80	100	P2 100mm	100
120	95	50	70	P2 150mm	100
130	95	60	80	P2 150mm	100
140	95	70	90	P2 150mm	100
150	95	80	100	P2 150mm	100
160	95	90	110	P2 150mm	100
170	145	50	70	P2 200mm	100
180	145	60	80	P2 200mm	100
190	145	70	90	P2 200mm	100
200	145	80	100	P2 200mm	100
210	145	90	110	P2 200mm	100
220	145	100	120	P2 200mm	100
230	145	110	130	P2 200mm	100
240	145	120	140	P2 200mm	100
250	145	130	150	P2 200mm	100
260	145	140	140	P2 200mm	100

All table measurements in mm



**Drive Tool**

**P2 Recess**

Drive bit size and lengths are shown in the table to the right.

ETA CE  
 ETA-07/0013  
 See Page 5

**NEW**

HTK 2G Plug available for liquid applied systems.

**ASK FOR DETAILS.**

# TKE stainless steel fastener + HTK 2G 75 combination

HTK 2G 75 tube-washer / TKE A4 grade steel fastener

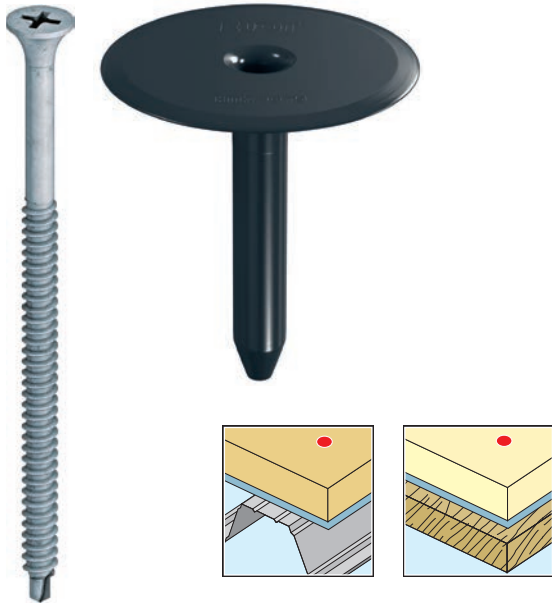

TKE

### Application

Insulation back to 0.7mm to 1.2mm steel deck  
 Insulation to plywood deck a minimum of 18mm in thickness  
 Thermally broken fastener/washer combination for minimal cold bridging

### Tube-washer detail

For HTK 2G 75 tube-washer detail and material specification - see page 7.

### Fastener detail

For TKE stainless steel fastener application detail and material specification - please see page 10.

### Drive Tool



Drive bit size and lengths are shown in the table to the right.



ETA-07/0013  
 See Page 5



### Recommended combinations:

Using the guide below, read across to match insulation depth to length of HTK tube-washer and correct combination of TKE fastener.

Insulation Thickness	HTK Length	TKE Length - Steel Deck	TKE Length - Plywood Deck	Drive Bit	Min Qty
60	35	50	70	P2 100mm	100
70	35	60	80	P2 100mm	100
80	55	50	70	P2 100mm	100
90	55	60	80	P2 100mm	100
100	55	70	90	P2 100mm	100
110	55	80	100	P2 100mm	100
120	95	50	70	P2 150mm	100
130	95	60	80	P2 150mm	100
140	95	70	90	P2 150mm	100
150	95	80	100	P2 150mm	100
160	95	90	100	P2 150mm	100
170	145	50	70	P2 200mm	100
180	145	60	80	P2 200mm	100
190	145	70	90	P2 200mm	100
200	145	80	100	P2 200mm	100
210	145	90	110	P2 200mm	100
220	145	100	120	P2 200mm	100

All table measurements in mm

### Products to save time and make installation easier



### EJOT easy reach 'Pouch Bag'

Provides fast, easy access to your fastener / washer combinations.

See page 11



### EJOT M6 x 600mm extension bar

Install straight from bag to deck and no bending. Simplicity in a 'click'!

See page 11

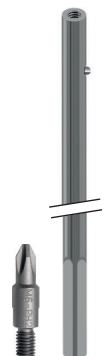

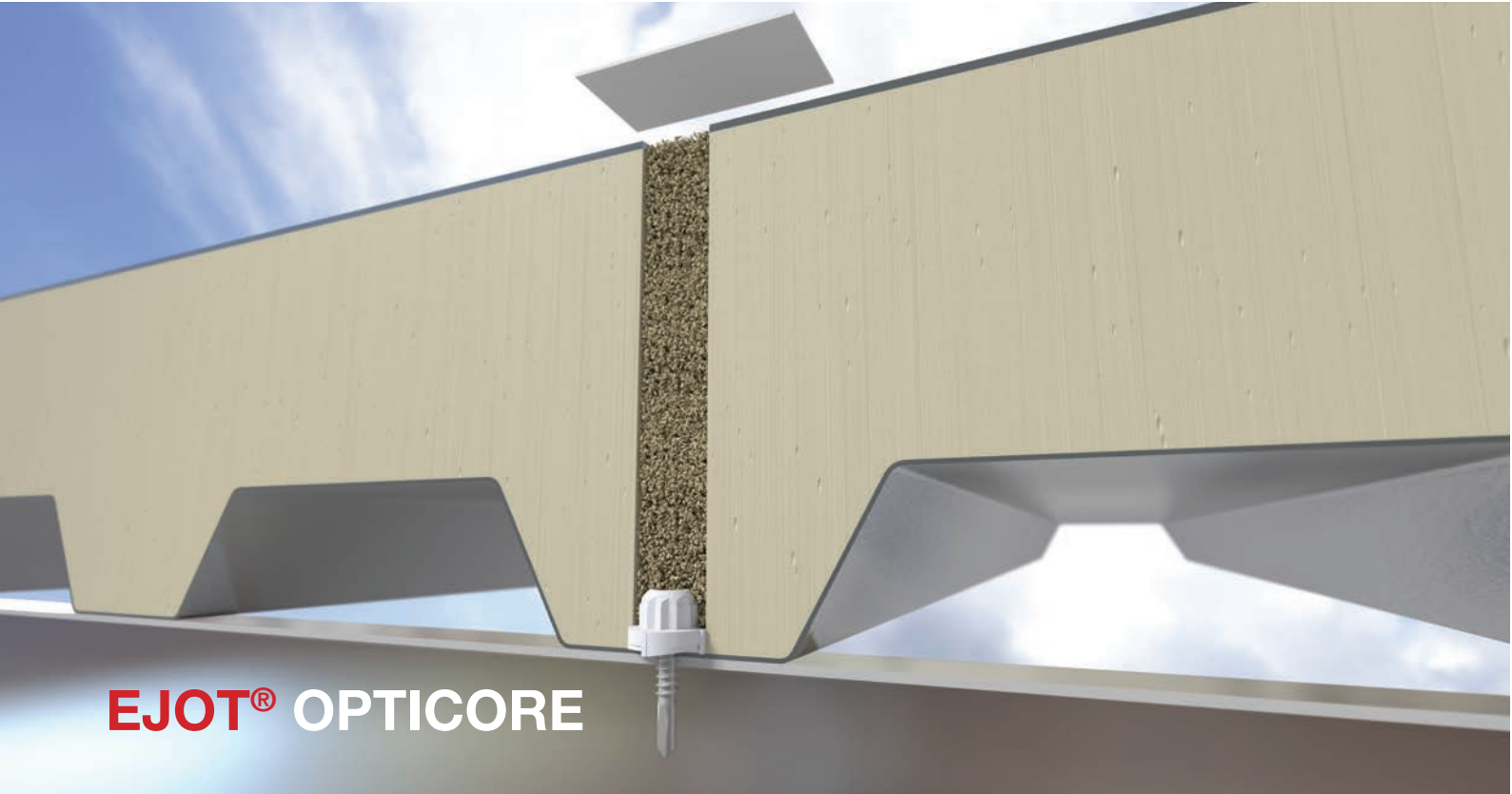

## The self-coring one-step fix for membrane faced composite panels

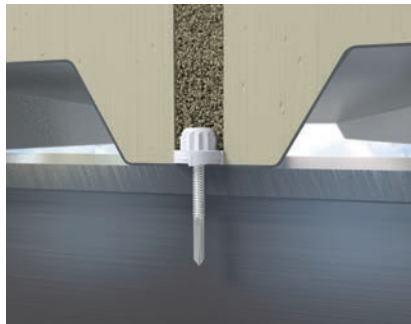

OPTICORE is EJOT's unique and patented integral nylon head, designed to encapsulate fasteners from our high-performance self-drilling range. OPTICORE is engineered to provide a dual drive fastening system that enables rapid self-coring of membrane faced insulation panels, and a secure fix into hot and cold rolled steel, and timber.

Key to OPTICORE's advantage is the coring action created by strategically placed cutting fins. These simply snap free as the fastener 'pulls up' and the nylon to metal relationship means there is no compromise to the integrity of the panel's lining skin. The composition of the OPTICORE head also provides significantly better thermal retention values over metal counterparts.



## EJOT® Opticore

Opticore's patented core-drilling head integrates with EJOT's high performance self-drilling fastener range

**Dual drive options for rapid self-coring and installation into all substrates.** The innovative design of the Opticore head provides installers with a choice of drive tools:

An internal T30 Plus creates a fast and secure installation where stitching or fixing to cold rolled steel. Once driven home the torque applied during installation strips out the nylon teeth within the drive recess, creating a perfect fix every time.

An 11mm bi-hex external drive bar provides an improved 'surface over fix' ratio, creating a far more responsive installation into hot rolled steel and timber substrates.

The integral Opticore head design is manufactured in high strength moulded nylon. The 'cutting fins' are unique to the Opticore patent and create the smooth coring of the panel's insulation. On secure 'pull-up' of the fastener into the substrate, the fins simply snap away without any compromise to the integral lining.

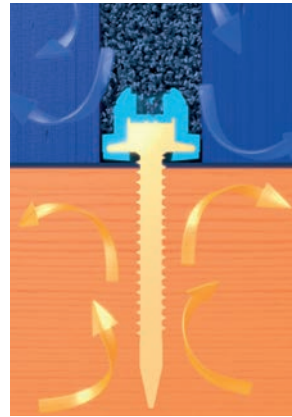

A combination of hot box tests and thermal activity recording at EJOT's testing centre Applitec, has repeatedly shown that the composition of the Opticore head provides significantly better thermal retention values over all-metal fastenings.

### Designed to encapsulate EJOT® self-drilling fasteners

The Opticore head is designed to encapsulate all high-performance fasteners from our self-drilling range, creating a fast one-step fix for stitching, light section steel, heavy section steel and plywood.

### Opticore Fasteners in Carbon Steel

High quality case hardened carbon steel with corrosion resistant coating.

Order description	Length (mm)	Diameter (mm)	Min Qty
Opticore SF 6.3 x 25	25	6.3	100
Opticore LS 5.5 x 32	32	5.5	100
Opticore HS 5.5 x 38	38	5.5	100
Opticore TS 6.3 x 45	45	6.3	100

SF 6.3 x 25



LS 5.5 x 32



HS 5.5 x 38



TS 6.3 x 45



### Opticore Fasteners in Stainless Steel

High quality stainless steel grade A2 to ISO 3506, EN 1.4301 to ISO 10088, AISI 304. Also available in A4.

Order description	Length (mm)	Diameter (mm)	Min Qty
Opticore JT3-2-6.3 x 25	25	6.3	100
Opticore JT3-2-5.5 x 25	25	5.5	100
Opticore JT3-12-5.5 x 40	40	5.5	100
Opticore JT3-2-6.5 x 50	50	6.5	100

JT3-2-6.3 x 25



JT3-3 5.5 x 25



JT3-12-5.5 x 40



JT3-2-6.5 x 50



### OPTICORE Drive Bars

- OPTICORE External Drive Bar 11mm Bi-Hex
- OPTICORE Internal Drive Bar Torx 30 Plus
- OPTICORE 1/4" EXT Hex Drive bar 11mm ext



**EJOT® EJOBAR**

Membrane-friendly bridging and support bar for single ply PVC roofing



EJOBAR is EJOT's membrane-friendly solution for securing or carrying mechanical & electrical essentials through to lightweight solar PV and thermal installations.

Fixing EJOBAR is easy. Installation is either by hot welding or for some applications, it can be simply used free-standing as a carrier system.



## EJOT® EJOBAR

### Strength of weld and pull out performance

EJObar has been subjected to rigorous strength-of-weld tests at our Applitec Development and Testing Centre. Here, a number of leading reinforced PVC membranes were subject to a like for like programme of tensometer procedures. EJObar surpassed performance expectations (note: loading can vary dependent upon the membrane manufacturer and type, therefore please consult EJOT Technical).

When on site, always check a sample weld first to ensure that the optimum weld temperature is set and follow the cleaning and welding procedures set by the membrane manufacturer.

EJObar is formally approved by the following leading PVC membrane manufacturers: Renolit, Flag Soprema, Fatra, Wolfin for specific solar installations - and IKO for mechanical and electrical applications.

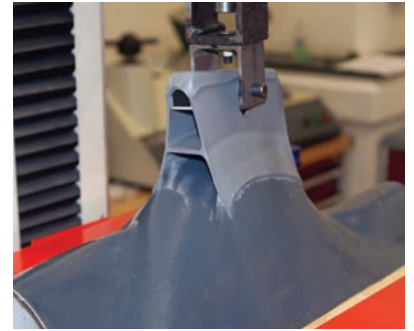

### Core strength

At the heart of every EJObar is a strong, 2mm thick aluminium bar.

On all standard lengths, the aluminium insert runs the full length of the product providing EJObar's load bearing strength, whilst creating a perfect fixing base for EJOT's JF3 self-drilling fastener.

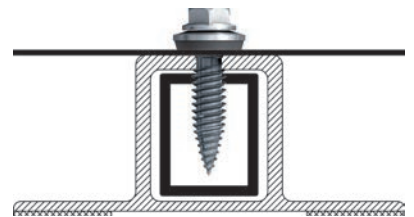

### Quality in profile

EJObar's 'top hat' profile is 100% top quality. Comprising of a thermoplastic membrane based on monomeric PVC-P, this extremely resilient PVC will stand up to the toughest environments.

### Secure fastening to EJObar

Manufactured from A2 austenitic stainless steel, its hardened carbon steel pierce point displaces material and will not rip EJObar's membrane sleeve. The fastener has European Technical approval ETA-10/0200.

EJOfast is also available as a JF6 variant manufactured from A4 austenitic stainless steel, for specific applications.



### Available in practical lengths

EJObar is supplied in a range of practical lengths and is available from the EJOT UK online webshop. You can choose from 0.3m and 0.5m for mechanical & electrical applications - 1.0m and 3.0m for PV solar installations.

#### For Mechanical applications use

EJObar PVC 300mm  
EJObar PVC 500mm

#### For Solar applications use

EJObar PVC 1000mm  
EJObar PVC 3000mm

#### For unusual applications

EJObar is a practical and flexible solution and can be deployed where the PVC membrane is creating pitch or shape. Call EJOT's technical team on 01977 687040.

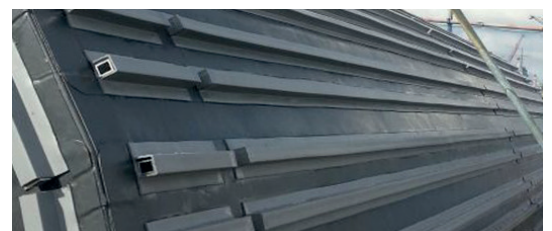

## EJOT® technical support on-site

When specifying outside of any standard technical parameters our technical team may recommend a thorough test report, carried out on site by a qualified EJOT engineer.

The reason is straightforward. Whilst we can be sure of the technical performance of our products, no-one can second guess the integrity of substrates. Where high loadings into critical structural areas create potential risk, we want our customers to have absolute peace of mind and confidence in the match between fixing and substrate - and the correct installation process.



### Much more than ‘added value’

Whether it’s ourselves instigating the survey, or the installer, contractor or a structural engineer - our technical team will gather information in advance. That means our engineers are briefed on product, substrate, and the impact of climate and environmental conditions.

With site-induction cleared, the testing process will follow set procedures that have been developed by EJOT’s technical teams globally.

Our engineers then compile a report. This data provides a mean-average conclusion that will enable any specifier to compare loadings against the necessary European Technical Approval specifications.

### Typical site test process

- **Identification**  
EJOT’s technical support team will assess the product application specification.
- **Recommendation**  
This may require an on-site test survey. Alternatively, anyone in the specification to installation chain may make this request.
- **Information**  
Our technical team will issue a ‘site test requisition form’ in advance.
- **Survey**  
Multiple points are tested to point of substrate failure.
- **Results**  
Compiled and data documented for assessment.

## EJOT® technical support off-site

EJOT APPLITEC is at the heart of our operations worldwide; the design, origination, testing and manufacturing of progressive fastening systems that provide high installation performance and longevity in application.

Here in the UK, our APPLITEC Centre has become an industry-wide resource, often in partnership with leading OEMs, sharing an objective to develop better, more efficient products for the modern building envelope.



### Wind loading calculations

Correct fixing specifications for mechanical or part-mechanical roofing installations for PVC membrane applications, require specific wind-loading calculations from EJOT's technical team and from the insulation manufacturers.

### Environmental conditions and specification

EJOT's technical support includes advice and real-time performance forecasting relating to known environmental conditions. This includes accurate and latest data relating to the choice of fastener material and corrosion resistance.

### Tapered systems and unusual designs

Where design specifications deploying PVC membrane are anything but 'flat', our technical team are able to guide designers, specifiers and installers with the correct combination of tube and fastener for all depths of insulation. Calculations yield a straightforward guide to the minimum and maximum installation depths and the quantity of insulation boards required.

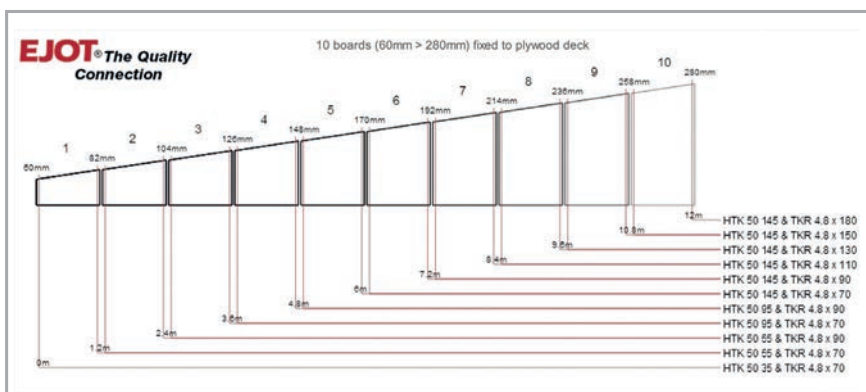

# The complete solution for the modern building envelope

EJOT's fastening systems encompass every facet of the modern building envelope and this range is complemented by other highly specialist products and systems, all designed, manufactured and supported by the EJOT Group, worldwide.

## Ask about our product and service literature for:

- Rainscreen, steel framing and insulation
- ETICS and external wall insulation
- Roofing and cladding
- Metal anchoring systems for concrete substrates
- Best practice guides



## Buy online in the EJOT webshop

EJOT UK's webshop means you can buy our flat roofing and membrane systems fixings online.

- Technical information at a click
- Fast – easy to register, easy to navigate
- Quick search by product or by application
- Automatically creates your purchase history - saves valuable time
- **Scan the code right and visit our online webshop**



**Follow EJOT UK online**



EJOT UK Building  
Products Showcase



@ejot.uk



@ejotuk\_building



EJOT U.K. Limited,  
Hurricane Close,  
Sherburn Enterprise Park,  
Sherburn-in-Elmet,  
Leeds LS25 6PB.  
United Kingdom

Tel: 01977 68 70 40  
Fax: 01977 68 70 41  
Email: [info@ejot.co.uk](mailto:info@ejot.co.uk)

[www.ejot.co.uk](http://www.ejot.co.uk)



**EJOT® The Quality Connection**